



RUUKKI
Building your tomorrow.

RUUKKI CENU KATALOGS

Mazumtirdzniecības cenas no 15.04.2025.



Ruukki Hyygge



Ruukki Classic



Ruukki Adamante



Ruukki Monterrey FEB forma



Ruukki Frigge

Saturs

Kvalitātes klases	3
Jumta segumi	4-8
Standarta papilddetajas	9-20
Skrūves, blīvējumi un citi piederumi	21-23
Ventilācijas izvadi un pieslēgumi	24-25
Ūdensnoteku sistēmas	26-36
Soffit dzegas apšuvums	37

Jumta drošības elementi	38-44
Profilētās loksnes sienām	45-46
Tērauda loksnes	47
Ruukki Classic portfolio	48-49
Ruukki dakstiņprofilu portfolio	50
Ruukki modulāro profilu portfolio	51

Ruukki kvalitātes klases

- lieliski
- ļoti labi
- labi
- apmierinoši



Kvalitātes klase	Ruukki® 50 Plus Matt	Ruukki® 40	Ruukki® 30 Plus Matt	Ruukki® 30
Pārklājuma struktūra	Strukturēts	Viegli strukturēts	Strukturēts	Gluds
Izskats	Matēts	Pusmatēts	Matēts	Spīdīgs
Nominālais pārklājuma biezums (µm)	50	26	30	25
Izturība pret UV-starojumu	●●●●● Ruv5	●●●●○ Ruv3	●●●●○ Ruv3	●●●○○ Ruv2-3
Izturība pret koroziju	●●●●● RC5+	●●●●○ RC5	●●●●○ RC4	●●●○○ RC3
Izturība pret skrāpējumiem	●●●●● ≥4000 g	●●●●○ ≥2500 g	●●●●○ ≥2500 g	●●●○○ ≥2000 g
Tehniskās garantijas termiņš (gadi)	50	40	30	30
Estētiskās garantijas termiņš (gadi)	25	15	10	10

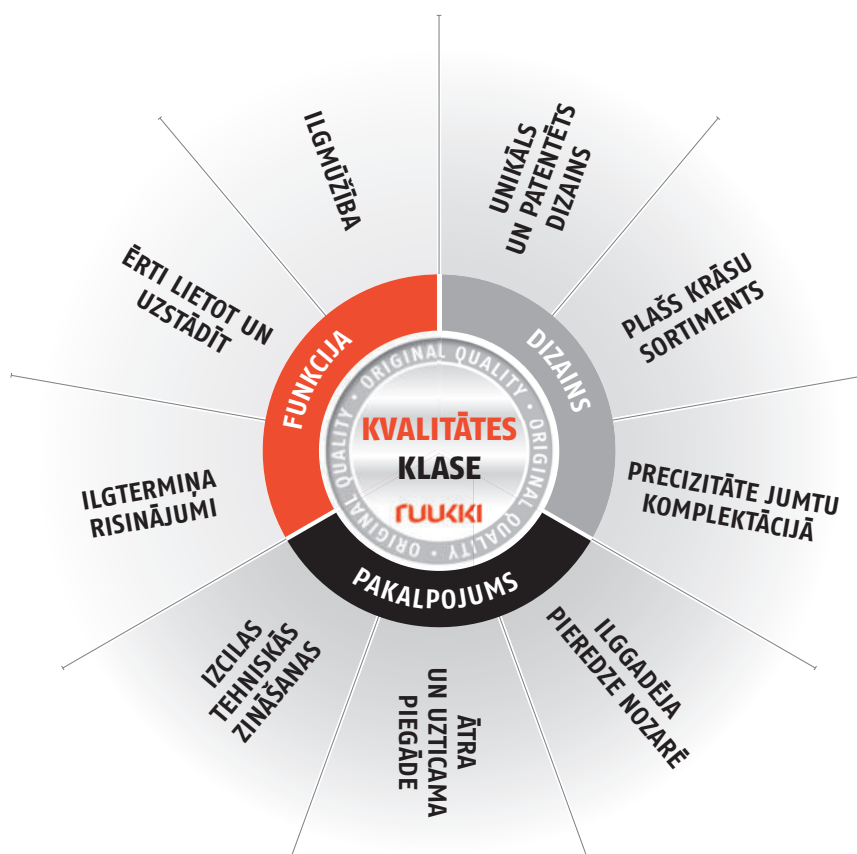

Ruukki jumta profilu cenas

Pasūtījumam zem 20 m² ražošanas uzsākšana ir 30 € bez PVN.

Katram cenu aprēķinam virs 20 m² tiek piemērota apjoma cena un/vai atlaide.

Vertikālo šuvju profili

Cena €/m² ar PVN (€/m² bez PVN)

Nosaukums	Ruukki® 50 Plus Matt	Ruukki® 30 Plus Matt
Classic Authentic Silence 0,6 mm C/D/M	38,66 (31,95)	
Classic Silence 0,5 mm C/D/M	36,18 (29,90)	29,77 (24,60)
Classic Authentic 0,6 mm C/D/M	32,61 (26,95)	
Classic 0,5 mm C/D/M	30,13 (24,90)	23,72 (19,60)
Classic Design 271mm 0,6 mm	37,99 (31,40)	
Classic Design 355mm 0,6 mm	33,76 (27,90)	
Classic Design 475mm 0,6 mm	32,61 (26,95)	
Classic Design 271mm 0,5 mm	34,12 (28,20)	
Classic Design 355mm 0,5 mm	30,98 (25,60)	
Classic Design 475mm 0,5 mm	30,13 (24,90)	
Valcprofils 0,6 mm SR27-535 A/B	30,73 (25,40)	
Valcprofils 0,5 mm SR27-545 A/B	27,35 (23,45)	

* ar mikroprofilējumu

Dakstiņveida profili

Cena €/m² ar PVN (€/m² bez PVN)

Nosaukums	Ruukki® 50 Plus Matt	Ruukki® 40	Ruukki® 30 Plus Matt	Ruukki® 30
Adamante TS55-350-1125	27,47 (22,70)		21,96 (18,15)	
Monterrey FEB Forma® TS44-350-1100	27,04 (22,35)	24,87 (20,55)		
Monterrey TS39-350-1100	26,32 (21,75)			17,24 (14,25)
Monterrey Eco TS39-350-1100				15,19 (12,55)

Modulārie profili

Cena €/gab ar PVN (€/gab bez PVN)

Nosaukums	Ruukki® 40
Ruukki® Hyygge 0,6 mm* TS26-290-1178	10,83 (8,95)
Finnera** TS52-330-1140	14,94 (12,35)
Frigge*** TS-41-350-1185	16,21 (13,40)

* paletē 180 gab., 1 gab. 0,341 m². ** paletē 310 gab., 1 gab. 0,75 m². *** paletē 200 gab., 1 gab. 0,83 m²

Profilētās jumta loksnes

Cena €/m² ar PVN (€/m² bez PVN)

Nosaukums	Ruukki® 50 Plus Matt	Ruukki® 30	Cinkots*
T20 0,5 mm T20-24W-1100	22,57 (18,65)	15,67 (12,95)	
T20 0,45 mm T20-24W-1100		14,82 (12,25)	
T45 0,5 mm T45-30W-905	26,38 (21,80)	18,99 (16,40)	18,27 (15,10)
T45 0,6 mm T45-30W-905			20,75 (17,15)
T45 0,7 mm T45-30W-905			23,41 (19,35)
T20 0,5 Antikon T20-24W-1100	26,50 (21,90)	19,60 (16,20)	
T45 0,5 Antikon T45-30W-905	30,31 (25,05)	23,78 (19,65)	

* ne mazāk kā 350 g/m² cinka

Ruukki jumtu krāsas un pārklājumi

	Kvalitātes klase	pārklājums	Melna	Antracīta	Tumši pelēka	Tumši brūna	Šokolādes brūna	Dakstiņu sarkana	Sarkana	Skujņu zaļa	Pelēka
			RR33	RR2H3	RR23	RR32	RR887	RR750	RR29	RR11	RR22

Vertikālo šuvju profili

Profilis	Ruukki®	Matēts	Melna	Antracīta	Tumši pelēka	Tumši brūna	Šokolādes brūna	Dakstiņu sarkana	Sarkana	Skujņu zaļa	Pelēka
Classic Authentic Silence 0,6 mm	Ruukki® 50 Plus Matt	matēts	•	•	•	•					
Classic Silence 0,5 mm	Ruukki® 50 Plus Matt	matēts	•	•	•	•	•	•	•	•	•
	Ruukki® 30 Plus Matt	matēts	•	•	•	•	•		•		
Classic Authentic 0,6 mm	Ruukki® 50 Plus Matt	matēts	•	•	•	•					
Classic C/D/M 0,5 mm	Ruukki® 50 Plus Matt	matēts	•	•	•	•	•	•	•	•	•
	Ruukki® 30 Plus Matt	matēts	•	•	•	•	•		•		
Classic Design 0,6 mm	Ruukki® 50 Plus Matt	matēts	•	•	•						
Valcprofils 0,6 mm	Ruukki® 50 Plus Matt	matēts	•	•	•	•					
Valcprofils 0,5 mm	Ruukki® 50 Plus Matt	matēts	•	•	•	•	•	•	•	•	•

Dakstiņveida profili

Profilis	Ruukki®	Matēts	Melna	Antracīta	Tumši pelēka	Tumši brūna	Šokolādes brūna	Dakstiņu sarkana	Sarkana	Skujņu zaļa	Pelēka
Adamante 0,5 mm	Ruukki® 50 Plus Matt	matēts	•	•	•	•	•	•	•	•	•
	Ruukki® 30 Plus Matt	matēts	•	•	•	•	•		•		
Monterrey FEB forma® 0,5 mm	Ruukki® 50 Plus Matt	matēts	•	•	•	•	•	•	•	•	•
	Ruukki® 40	pusmatēts	•	•	•	•	•		•		
Monterrey 0,5 mm	Ruukki® 30	spīdīgs	•	•	•	•	•	•	•	•	•
Monterrey Eco 0,45 mm	Ruukki® 30	spīdīgs			•	•					

Modulārie jumta profili

Profilis	Ruukki®	Matēts	Melna	Antracīta	Tumši pelēka	Tumši brūna	Šokolādes brūna	Dakstiņu sarkana	Sarkana	Skujņu zaļa	Pelēka
Hyygge 0,6 mm	Ruukki® 40	pusmatēts	•	•	•						
Finnera 0,5 mm	Ruukki® 40	pusmatēts	•	•	•	•	•		•		
Frigge 0,5 mm	Ruukki® 40	pusmatēts	•	•	•	•	•	•	•		

Profilētās jumta loksnes

Profilis	Ruukki®	Matēts	Melna	Antracīta	Tumši pelēka	Tumši brūna	Šokolādes brūna	Dakstiņu sarkana	Sarkana	Skujņu zaļa	Pelēka
T20 0,5 mm	Ruukki® 50 Plus Matt	matēts	•	•	•	•	•	•	•	•	•
	Ruukki® 30	spīdīgs	•	•	•	•	•	•	•	•	•
T20 0,45 mm	Ruukki® 30	spīdīgs			•	•					
T45 0,5 mm	Ruukki® 50 Plus Matt	matēts	•	•	•	•	•	•	•	•	•
	Ruukki® 30	spīdīgs	•	•	•	•	•	•	•	•	•

Vertikālo šuvju profili

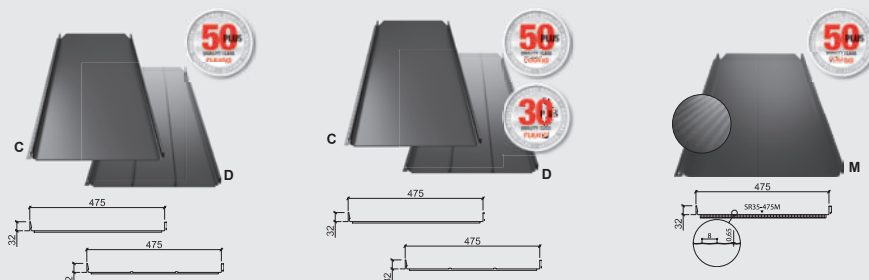

	CLASSIC AUTHENTIC / CLASSIC AUTHENTIC SILENCE	CLASSIC C/D / CLASSIC SILENCE	CLASSIC M / CLASSIC M SILENCE
Profila augstums	32 mm	32 mm	32 mm
Sedzošais platums	475 mm	475 mm	475 mm
Kopējais platums	505 mm	505 mm	505 mm
Maksimālais garums	12 500 mm	12 500 mm	12 500 mm
Minimālais garums	1 200 mm	1 200 mm	1 200 mm
Minimālais jumta slīpums	8°	8°	8°
Materiāla biezums	0,60 mm	0,50 mm	0,50 mm
Cinka daudzums	275 g/m ²	275 g/m ²	275 g/m ²
Svars	6,2 kg/m ²	5,2 kg/m ²	5,2 kg/m ²
Montāža abos virzienos	✓	✓	✓
Iestrādāts skaņas izolācijas slānis	Classic Silence versijā	Classic Silence versijā	Classic Silence versijā



Classic Silence versija (ar filcu)

- drošs, rūpnieciski iestrādāts filca slānis
- samazina lietus troksni līdz pat 40% (-6db)
- absorbē kondensātu



Šuves noseļements noslēpj šuvi un vienlaicīgi arī sargā Ruukki Classic profila lokšņu savienojuma mezglu.

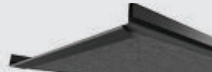

Profilēm Classic nolocīta priekšējā mala – aizsargā pret koroziju un ir vizuāli pievilcīgāka.

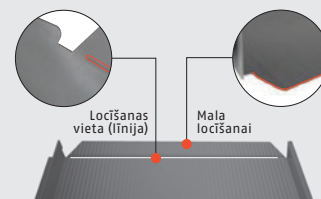

Classic augšējā loksnes mala sagatavota nolocīšanai pēc nepieciešamības. Iespējama montāža abos virzienos – no labās uz kreiso pusi un no kreisās uz labo. Atvieglo un paātrina montāžas procesu sarežģītāku jumtu konstrukciju gadījumos.

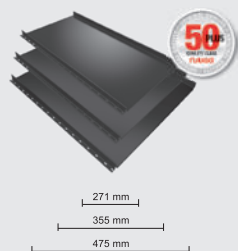

CLASSIC DESIGN 271/ 355/ 475 mm

Profila augstums	32 mm
Sedzošais platums	271/ 355/ 475 mm
Kopējais platums	300/ 390/ 510 mm
Maksimālais garums	10 500 mm
Minimālais garums	1 100 mm
Minimālais jumta slīpums	8°
Materiāla biezums	0,60 mm
Cinka daudzums	275 g/m ²
Svars	6,2 kg/m ²

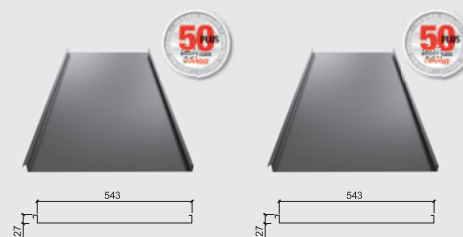

VALCPROFILS 0.5 mm VALCPROFILS 0.6 mm

Profila augstums	27 mm	27 mm
Sedzošais platums	543 mm	543 mm
Maksimālais garums	10 500 mm	10 500 mm
Minimālais garums	1 100 mm	1 100 mm
Minimālais jumta slīpums	5°	5°
Materiāla biezums	0.50 mm	0.60 mm
Cinka daudzums	275 g/m ²	275 g/m ²
Svars	4,5 kg/m ²	4,6 kg/m ²

Dakstiņveida profili

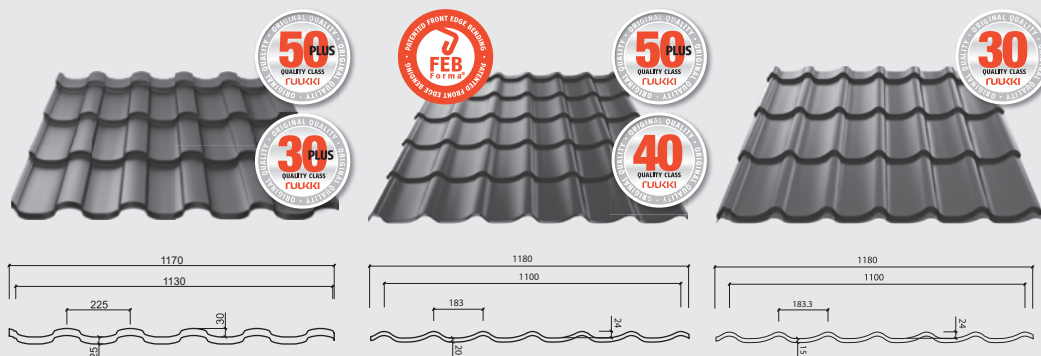

	ADAMANTE	MONTERREY FEB FORMA®	MONTERREY/ MONTERREY ECO
Profila augstums	55 mm	44 mm	39 mm
Sedzošais platums	1 130 mm	1 100 mm	1 100 mm
Kopējais platums	1 170 mm	1 180 mm	1 180 mm
Maksimālais garums	8 200 mm	8 000 mm	8 000 / 7 000 mm
Minimālais garums	800 mm	800 mm	800 mm
Minimālais jumta slīpums	14°	14°	14°
Materiāla biezums	0,50 mm	0,50 mm	0,50/0,45 mm
Cinka daudzums	275 g/m ²	275 g/m ²	275 g/m ²
Svars	4,8 kg/m ²	4,7 kg/m ²	4,7/4,1 kg/m ²

FEB Forma® – patentēta tehnoloģija bez asām malām, ar pilnīgu telpisku formu un noturīgāku funkcionalitāti.



Profilētas jumta loksnes

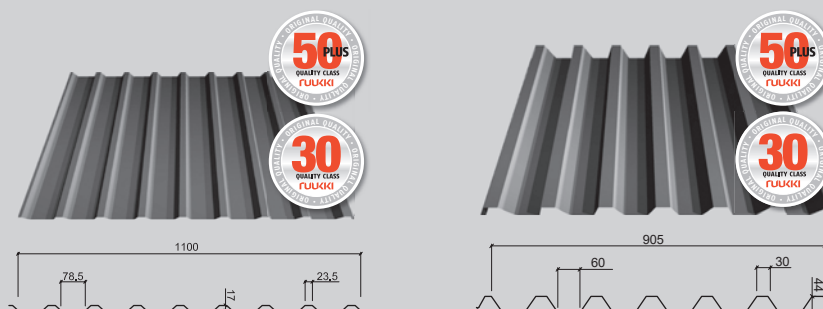

	T20	T45
Profila augstums	17 mm	41 mm
Attālums starp viļņiem	24 mm	61,5 mm
Sedzošais platums	1 100 mm	905 mm
Kopējais platums	1 140 mm	960 mm
Maksimālais garums	12 000 mm	13 000 mm
Minimālais garums	500 mm	500 mm
Minimālais jumta slīpums	11°	8°
Materiāla biezums krāsotam	0,45/0,50 mm	0,50 mm
Mat, biezums cinkotam	0,5–0,7 mm	0,5–0,7 mm
Cinka daudzums krāsotam	275 g/m ²	275 g/m ²
Cinka daudzums cinkotam	350 g/m ²	350 g/m ²
Svars	4,1–6,4 kg/m ²	5,42–7,77 kg/m ²

Modulārie jumta profili

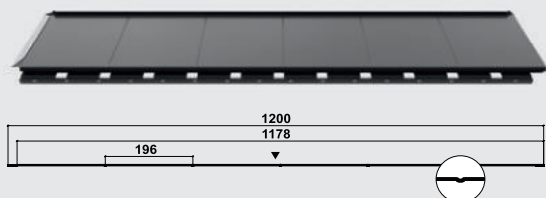

RUUKKI® HYYGGE

Profila augstums	26 mm
Loksnes garums	343 mm
Sedzošais garums	290 mm
Kopējais platums	1200 mm
Sedzošais platums	1178 mm
Minimālais jumta slīpums	25°
Materiāla biezums	0,6 mm
Cinka daudzums	275 g/m ²
Svars	2,35 kg/gab; 7 kg/m ²

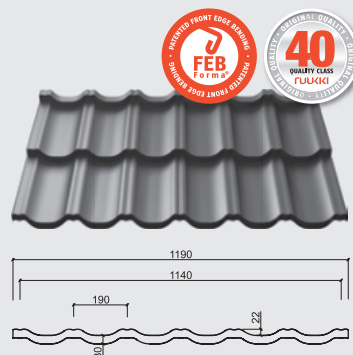

FINNERA

Profila augstums	52 mm
Vilņa garums	330 mm
Sedzošais platums	1140 mm
Kopējais platums	1190 mm
Sedzošais garums	660 mm
Kopējais garums	705 mm
Minimālais jumta slīpums	14°
Materiāla biezums	0.50 mm
Cinka daudzums	275 g/m ²
Vienas loksnes svars	3.8 kg/gab.

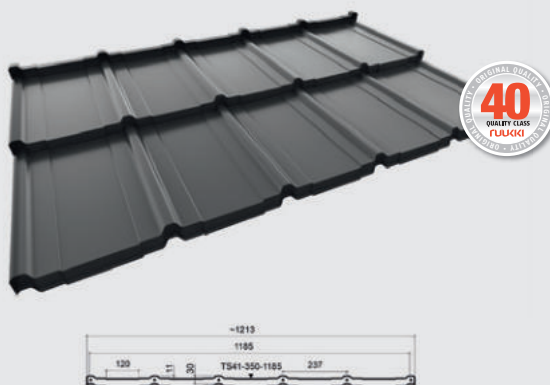

FRIGGE



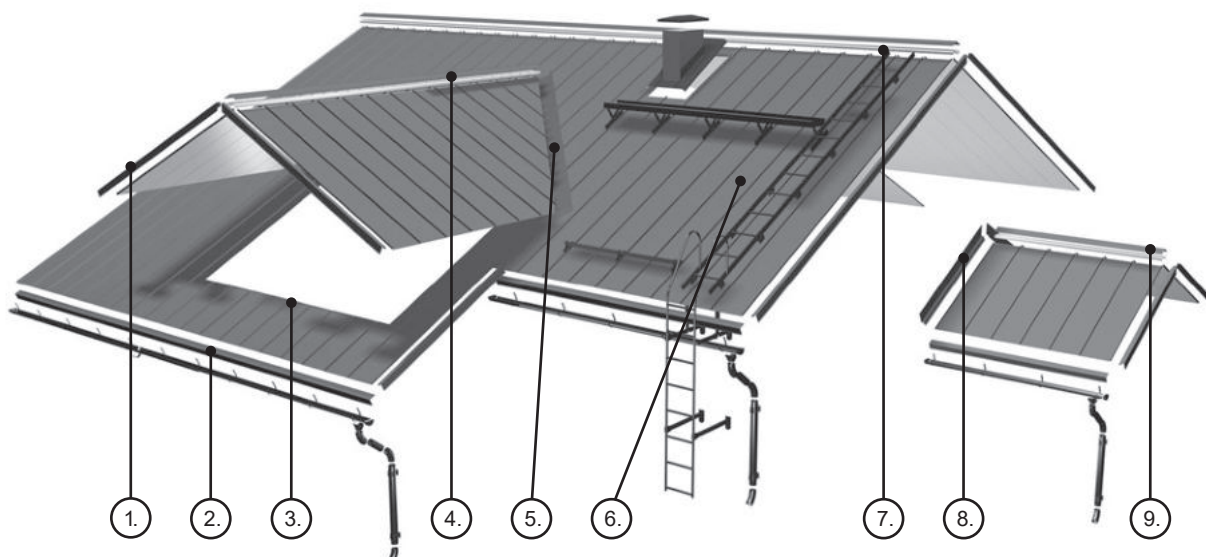

Profila augstums	41 mm
Vilņa garums	350 mm
Sedzošais platums	1185 mm
Kopējais platums	1213 mm
Sedzošais garums	700 mm
Kopējais garums	720 mm
Minimālais jumta slīpums	14°
Materiāla biezums	0.50 mm
Cinka daudzums	275 g/m ²
Vienas loksnes svars	3.9 kg/gab.





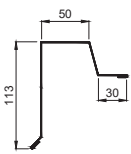

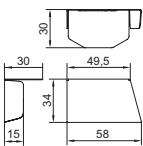
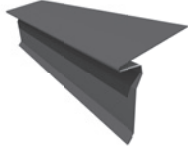
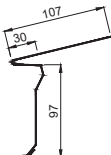

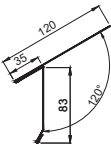

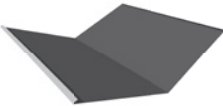
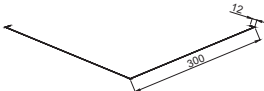
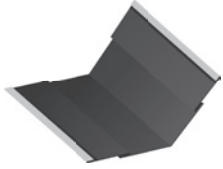
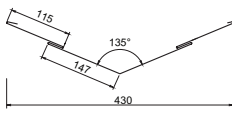

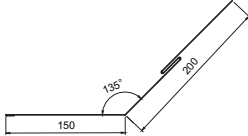

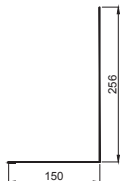
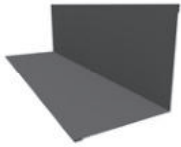
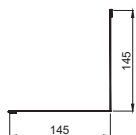

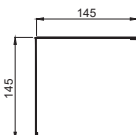

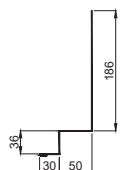

- | | | |
|-------------|---|------------------|
| 1. Vējdēlis | 4. Kore | 7. Apakšējā kore |
| 2. Karnīze | 5. Satekne | 8. Atloks |
| 3. Atloks | 6. Skaņas izolācija (vertikālo šuvju profiliem) | 9. Kore |

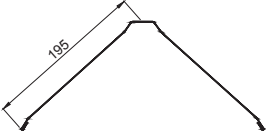
Standarta papilddetāļas vertikālo šuvju jumtu segumiem

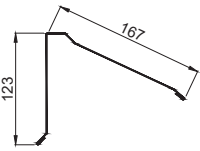
Cena €/gab. ar PVN (€/gab. bez PVN)

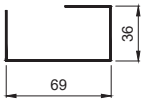

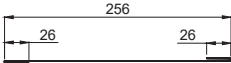





Attēls	Zīmējums	Nosaukums	Kvalitātes klases	
		Classic vējdēlis L = 2000 mm	Ruukki® 50 Plus Matt Ruukki® 30 Plus Matt	26,50 (21,90) 25,17 (20,80)
		Classic vējmalas dekoratīvais nobeigums Komplekts (kreisais + labais)	Ruukki® 50 Plus Matt	7,02 (5,80)
		Classic karnīze, lokāma L = 2000 mm	Ruukki® 50 Plus Matt (RR11, RR22, RR23, RR2H3, RR29, RR32, RR33, RR750)	23,16 (21,95)
		Classic karnīze L = 2000 mm	Ruukki® 50 Plus Matt Ruukki® 30 Plus Matt	27,35 (22,60) 24,62 (20,35)

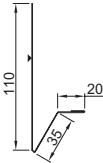

Attēls	Zīmējums	Nosaukums	Kvalitātes klases
		Satekne L = 2000 mm	Ruukki® 50 Plus Matt 51,30 (42,40) Ruukki® 30 Plus Matt 48,16 (38,80)
		Aizāķējamā Classic satekne L = 2000 mm	Ruukki® 50 Plus Matt 47,43 (39,20) Ruukki® 30 Plus Matt 43,08 (35,60)
		Savienojuma elements/atloks Classic L = 2000 mm	Ruukki® 50 Plus Matt 39,02 (32,25) Ruukki® 30 Plus Matt 33,15 (27,40)
		Atloks L = 2000 mm	Ruukki® 50 Plus Matt 35,45 (29,30) Ruukki® 30 Plus Matt 32,55 (26,90)
		Iekšējais stūris L = 2000 mm	Ruukki® 50 Plus Matt (RR887) 26,86 (22,20) Ruukki® 30 Plus Matt (RR887, RR2H3) 24,08 (19,90)
		Ārējais stūris L = 2000 mm	Ruukki® 50 Plus Matt 26,86 (22,20) Ruukki® 30 Plus Matt (RR887, RR2H3) 24,08 (19,90)
		Classic atloks L = 2000 mm	Ruukki® 50 Plus Matt 27,35 (22,60) Ruukki® 30 Plus Matt 24,81 (20,50)



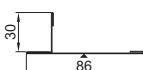



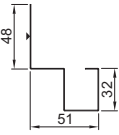

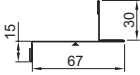

Attēls	Zīmējums	Nosaukums	Kvalitātes klases	
		Kore L = 2000 mm	Ruukki® 50 Plus Matt (RR887, RR2H3)	31,58 (26,10)
			Ruukki® 30 Plus Matt	28,18 (23,30)
		Augšējais stūris L = 2000 mm	Ruukki® 50 Plus Matt	26,14 (21,60)
			Ruukki® 30 Plus Matt	23,96 (19,80)
		Classic apakšējā kore	Ruukki® 50 Plus Matt L = 460 mm (pielāgots Ruukki Classic loksnēm)	4,96 (4,10)
			Ruukki® 50 Plus Matt L = 3000 mm	28,31 (23,40)
		Classic savienojuma detaļa (taisnai plaknei) L = 460 mm	ZN, 0.60 mm	7,02 (5,80)
		Ventilējama tērauda lata garums – 3700 mm augstums – 32 mm biezums – 0,7 mm		13,49 (11,15)

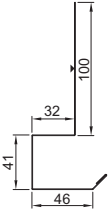

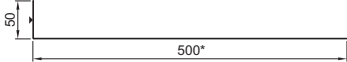



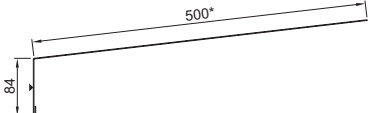

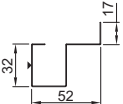

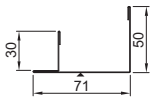
Papild detaļas Classic uzstādīšanai uz fasādēm

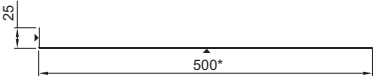
Cena €/gab. ar PVN (€/gab. bez PVN)

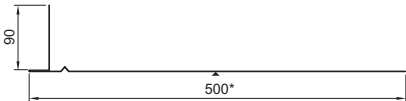
Attēls	Zīmējums	Nosaukums	Info	
		1. Starta elements cokolam L = 2400 mm	Slēptais elements Ruukki 40 RR2H3 0,50 mm	27,65 (22,85)
		2. Perforēts elements cokolam * - sagatave, izmēri pēc vajadzības L = 2400 mm * - cena ir spēkā norādītajiem izmēriem	Slēptais elements Ruukki 40 RR2H3 0,50 mm	44,17 (36,50)
		3. Ventilējama apakškore L = 460 mm L = 340 mm L = 255 mm	Ruukki® 50 Plus matt 0,50 mm	4,96 (4,10) 3,51 (2,90) 2,36 (1,95)
		4. Fasāžu savienojuma elements L = 2400 mm	Slēptais elements Ruukki 40 RR2H3 0,50 m	28,19 (23,30)
		5. Fasāžu savienojuma noselements L = 3000 mm	Ruukki® 50 Plus matt 0,50 mm	28,19 (23,30)
		6. Classic lokšņu savienojuma detaļa L=271 mm L=340 mm L=460 mm	Ruukki® 50 Plus matt 0,50 mm	5,45 (4,50) 5,99 (4,95) 7,02 (5,80)

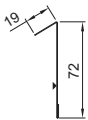
Attēls	Zīmējums	Nosaukums	Info	
		7. Ārējā / iekšējā stūra elements L = 2400 mm	Slēptais elements Ruukki 40 RR2H3 0,50 mm	20,45 (16,90)
		8. Ārējā stūra nosegelements L = 3000 mm	Ruukki® 50 Plus matt 0,50 mm	60,32 (49,85)
		9. Iekšējā stūra nosegelements L = 3000 mm	Ruukki® 50 Plus matt 0,50 mm	48,04 (39,70)
		10. Ārējā stūra nobeiguma elements L = 2400 mm	Slēptais elements Ruukki 40 RR2H3 0,50 mm	30,13 (24,90)
		11. Ārējā stūra nobeiguma nosegelements L = 3000 mm	Ruukki® 50 Plus matt 0,50 mm	48,04 (39,70)
		12. Iekšējā stūra nobeiguma elements L = 2400 mm	Slēptais elements Ruukki 40 RR2H3 0,50 mm	30,13 (24,90)

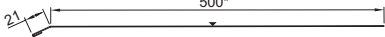
Attēls	Zīmējums	Nosaukums	Info	
		13. Iekšējā stūra nobeiguma noselements	Ruukki® 50 Plus matt	32,07 (26,50)
		L = 3000 mm		
		14. Loga / durvju augša	Ruukki® 50 Plus matt 0,50 mm	41,99 (34,70)
		L = 2400 mm		
		15. Loga / durvju aile augša	Ruukki® 50 Plus matt 0,50 mm	43,92 (36,30)
		* - sagatave, izmēri pēc vajadzības L = 2400 mm		
		16. Apakšējais palodzes elements (platais)	Slēptais elements Ruukki 40 RR2H3 0,50 mm	11,62 (9,60)
		L = 2400 mm		
		17. Palodzes elements (platais)	Ruukki® 50 Plus matt 0,50 mm	43,92 (36,30)
		* - sagatave, izmēri pēc vajadzības L = 2400 mm		
		18. Loga / durvju sānu elements	Slēptais elements Ruukki 40 RR2H3 0,50 mm	30,13 (24,90)
		L = 2400 mm		

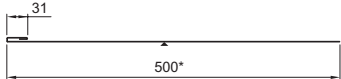
Attēls	Zīmējums	Nosaukums	Info	
		19. Loga / durvju sānu nosegelements L = 3000 mm	Ruukki® 50 Plus matt 0,50 mm	41,99 (34,70)
		20. Loga durvju ailes sānu nosegelements * - sagatave, izmēri pēc vajadzības L = 3000 mm	Ruukki® 50 Plus matt 0,50 mm	49,55 (40,95)
		21. Šaura loga/ durvju augša * - sagatave, izmēri pēc vajadzības L = 2400 mm	Ruukki® 50 Plus matt 0,50 mm	57,54 (47,55)
		22. Šaurās logu/ durvju palodzes elements L = 2400 mm	Ruukki® 50 Plus matt 0,50 mm	57,54 (47,55)
		23. Palodze (šaura) * - sagatave, izmēri pēc vajadzības L = 2400 mm	Ruukki® 50 Plus matt 0,50 mm	45,72 (38,10)
		24. Šaurās logu/ durvju ailes sānu elements * - sagatave, izmēri pēc vajadzības L = 3000 mm	Ruukki® 50 Plus matt 0,50 mm	51,66 (43,05)



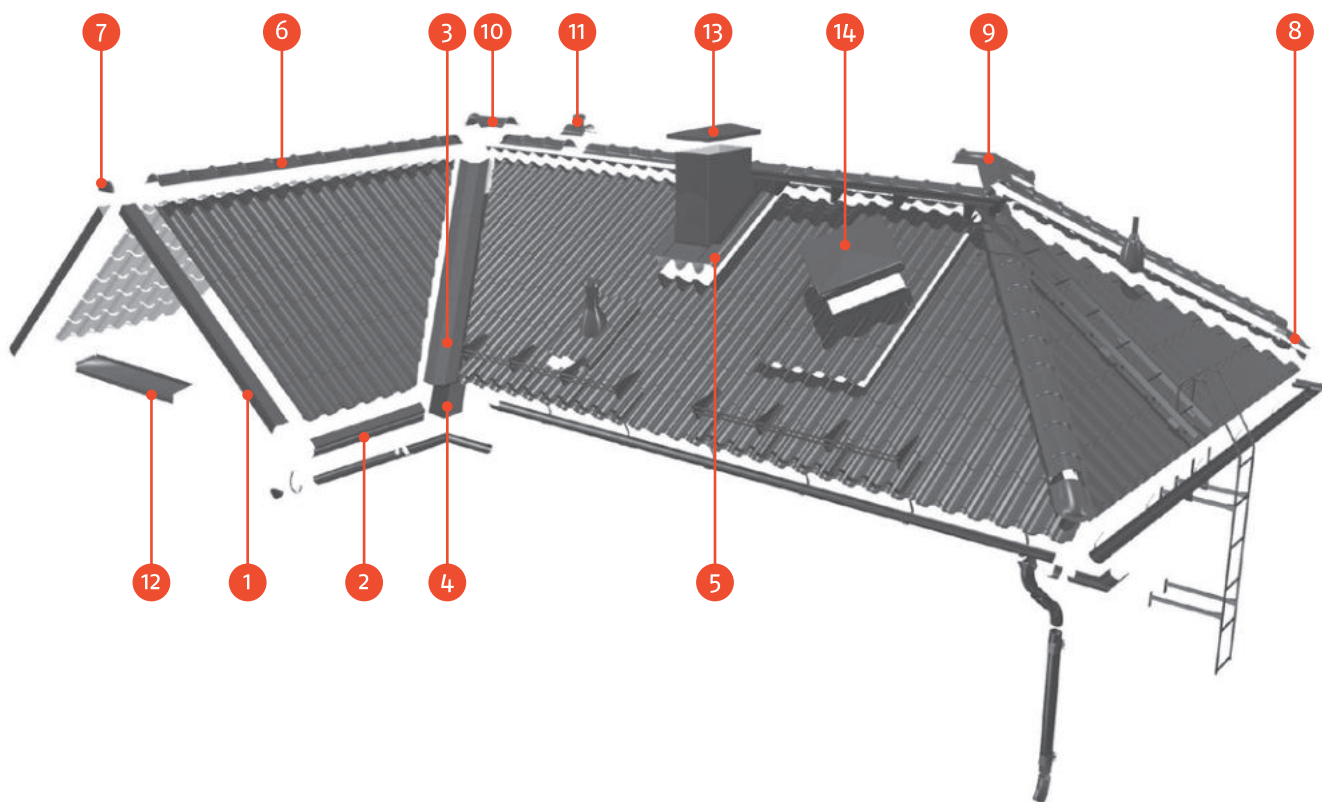





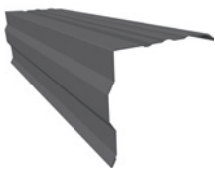
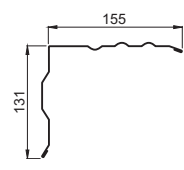
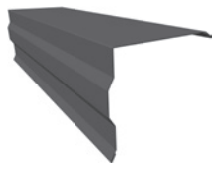
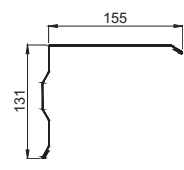

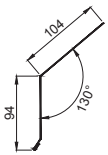
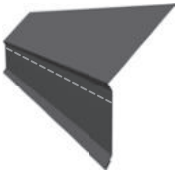
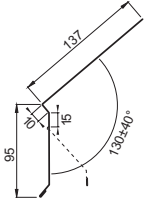
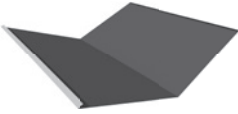
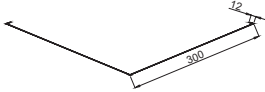
Standarta papild detaļas dakstiņveida un profilētajiem jumtu segumiem

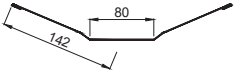

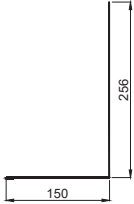
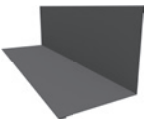
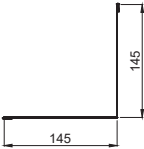

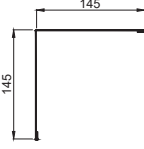

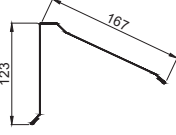

- 1 Vējdēlis
- 2 Karnīze
- 3 Augšējā satekne
- 4 Satekne
- 5 Atloks
- 6 Apaļā kore
- 7 Apaļās kores gala elements
- 8 Apaļās kores gala elements
- 9 Y formas kores savienojums
- 10 T formas kores savienojums
- 11 Kores ventilācijas izvads
- 12 Palodze
- 13 Skursteņa pieslēgums
- 14 Sarežģītas formas papild detaļas

Cena €/gab. ar PVN (€/gab. bez PVN)

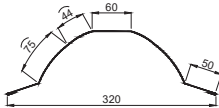
Attēls	Zīmējums	Nosaukums	Info								
		Vējdēlis L = 2000 mm	<table border="0"> <tr> <td>Ruukki® 50 Plus Matt (RR11, RR23, RR29, RR32, RR33, RR750)</td> <td style="text-align: right;">27,59 (22,80)</td> </tr> <tr> <td>Ruukki® 40 (RR23, RR29, RR32, RR33)</td> <td style="text-align: right;">24,93 (20,60)</td> </tr> <tr> <td>Ruukki® 30 (RR23, RR29, RR32, RR33)</td> <td style="text-align: right;">24,08 (19,90)</td> </tr> </table>	Ruukki® 50 Plus Matt (RR11, RR23, RR29, RR32, RR33, RR750)	27,59 (22,80)	Ruukki® 40 (RR23, RR29, RR32, RR33)	24,93 (20,60)	Ruukki® 30 (RR23, RR29, RR32, RR33)	24,08 (19,90)		
Ruukki® 50 Plus Matt (RR11, RR23, RR29, RR32, RR33, RR750)	27,59 (22,80)										
Ruukki® 40 (RR23, RR29, RR32, RR33)	24,93 (20,60)										
Ruukki® 30 (RR23, RR29, RR32, RR33)	24,08 (19,90)										
		Vējdēlis L = 2000 mm	<table border="0"> <tr> <td>Ruukki® 50 Plus Matt</td> <td style="text-align: right;">27,59 (22,80)</td> </tr> <tr> <td>Ruukki® 40</td> <td style="text-align: right;">24,93 (20,60)</td> </tr> <tr> <td>Ruukki® 30 Plus Matt</td> <td style="text-align: right;">24,93 (20,60)</td> </tr> <tr> <td>Ruukki® 30</td> <td style="text-align: right;">24,08 (19,90)</td> </tr> </table>	Ruukki® 50 Plus Matt	27,59 (22,80)	Ruukki® 40	24,93 (20,60)	Ruukki® 30 Plus Matt	24,93 (20,60)	Ruukki® 30	24,08 (19,90)
Ruukki® 50 Plus Matt	27,59 (22,80)										
Ruukki® 40	24,93 (20,60)										
Ruukki® 30 Plus Matt	24,93 (20,60)										
Ruukki® 30	24,08 (19,90)										









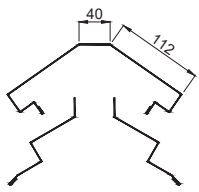

Attēls	Zīmējums	Nosaukums	Info
		Karnīze L = 2000 mm	Ruukki® 50 Plus Matt 27,35 (22,60) Ruukki® 40 24,62 (20,35) Ruukki® 30 Plus Matt 24,62 (20,35) Ruukki® 30 23,47 (19,40)
		Karnīze, lokāmā L = 2000 mm	Ruukki® 50 Plus Matt (RR11, RR23, RR29, RR32, RR33, RR750) 27,35 (22,60) Ruukki® 40 (RR23, RR29, RR32, RR33) 24,62 (20,35) Ruukki® 30 (RR11, RR23, RR29, RR32, RR33, RR750) 23,47 (19,40)
		Satekne Adamante Finnera Monterrey FEB Forma® T20 L = 2000 mm	Ruukki® 50 Plus Matt 51,30 (42,40) Ruukki® 40 48,16 (39,80) Ruukki® 30 Plus Matt 48,16 (39,80) Ruukki® 30 45,74 (37,80)
		Augšējā satekne Adamante Finnera Monterrey FEB Forma® T20 L = 2000 mm	Ruukki® 50 Plus Matt 30,98 (25,60) Ruukki® 40 29,40 (24,30) Ruukki® 30 Plus Matt 29,40 (24,30) Ruukki® 30 27,59 (22,80)
		Atloks Adamante Finnera Monterrey FEB Forma® T20 L = 2000 mm	Ruukki® 50 Plus Matt 35,57 (29,40) Ruukki® 40 32,55 (26,90) Ruukki® 30 Plus Matt 32,55 (26,90) Ruukki® 30 30,85 (25,50)
		Iekšējais stūris Adamante Finnera Monterrey FEB Forma® T20 L = 2000 mm	Ruukki® 50 Plus Matt 26,86 (22,20) Ruukki® 40 24,08 (19,90) Ruukki® 30 Plus Matt 24,08 (19,90) Ruukki® 30 22,81 (18,85)
		Ārējais stūris Adamante Finnera Monterrey FEB Forma® T20 L = 2000 mm	Ruukki® 50 Plus Matt 26,86 (22,20) Ruukki® 40 24,08 (19,90) Ruukki® 30 Plus Matt 24,08 (19,90) Ruukki® 30 22,81 (18,85)
		Augšējais stūris Adamante Finnera Monterrey FEB Forma® T20 L = 2000 mm	Ruukki® 50 Plus Matt 26,50 (21,90) Ruukki® 40 23,47 (19,40) Ruukki® 30 Plus Matt 23,47 (19,40) Ruukki® 30 22,50 (18,60)
		Kore Adamante Finnera Monterrey FEB Forma® T20 L = 2000 mm	Ruukki® 50 Plus Matt 31,58 (26,10) Ruukki® 40 28,19 (23,30) Ruukki® 30 27,70 (22,90)

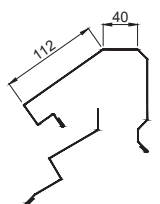
Cena €/gab. ar PVN (€/gab. bez PVN)

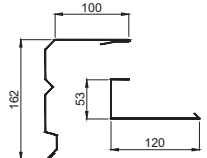
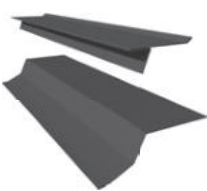
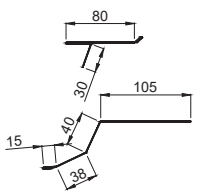
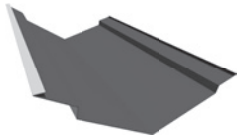
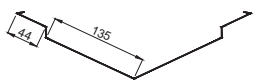
Attēls	Zīmējums	Nosaukums	Info	
		Apaļā kore	Ruukki® 50 Plus Matt	36,12 (29,85)
		Adamante Finnera Monterrey FEB Forma® T20 L = 2100 mm	Ruukki® 40	34,30 (28,35)
			Ruukki® 30 Plus Matt	34,30 (28,35)
			Ruukki® 30	32,91 (27,20)
		Kores gals, noapajots	Plastmasa	20,81 (17,20)
		Adamante Finnera Monterrey FEB Forma® T20		
		Kores gals	Plastmasa	7,20 (5,95)
		Adamante Finnera Monterrey FEB Forma® T20		
		Y formas kores savienojums	Plastmasa	35,82 (29,60)
		Adamante Finnera Monterrey FEB Forma® T20		
		Kores ventilācijas izvads no apaļās kores	Plastmasa	47,80 (39,50)
		Adamante Finnera Monterrey FEB Forma® T20		
		Kores ventilācijas izvads no kores	Plastmasa	47,80 (39,50)
		Adamante Finnera Monterrey FEB Forma® T20		

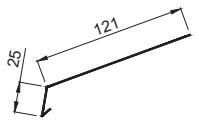
Standarta papildetaļas modulārajam profilam Ruukki® Hygge®

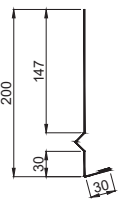
Cena €/gab, ar PVN (€/gab. bez PVN)

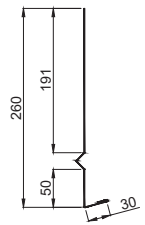
Attēls	Zīmējums	Nosaukums	Kvalitātes klase	
		Kore Hygge Komplekts no 3 elementiem. Iepakojumā 4 komplekti. L = 2000 mm	Ruukki® 40	47,00 (38,85)
		Augšējais stūris Hygge Komplekts no 2 elementiem. Iepakojumā 4 komplekti. L = 2000 mm	Ruukki® 40	38,35 (31,70)
		Vējadēlis Hygge Komplekts no 2 elementiem. Iepakojumā 4 komplekti. L = 2000 mm	Ruukki® 40	58,75 (48,55)
		Karnīze Hygge Komplekts no 2 elementiem. Iepakojumā 4 komplekti. L = 2000 mm		26,71 (21,75)
		Satekne Hygge L = 2000 mm	Ruukki® 40	40,17 (33,20)
		Kondensācijas sloksne apakšklājam Hygge L = 2000 mm	Ruukki® 40	15,91 (13,15)
		Vējmalas apdare (mazā) L = 2000 mm	Ruukki® 40	22,68 (18,75)
		Vējmalas apdare (lielā) L = 2000 mm	Ruukki® 40	26,19 (21,65)









Cena €/gab, ar PVN (€/gab. bez PVN)

Attēls	Zīmējums	Nosaukums	Kvalitātes klase
		Kores lats balsts ar naglu Hyygge 40 x 210 mm	1,33 (1,10)
		Kores lats balsts regulējams Hyygge 40 x 202–225 mm	2,78 (2,30)



* Modulārais profils Hyygge tiek pasūtīts iepakojumos. Par minimālajiem pasūtīšanas apjomiem precizējiet pie pārdevēja.

Skrūves, blīvējumi un citi piederumi

Skrūves













		Cena €/gab. ar PVN (€/gab. bez PVN)		
Attēls	Nosaukums	Info	Daudzums	
	Skrūves kokam 4.8 x 28 mm	krāsotas	100 gab./iepak.	11,56 (9,55)
		cinkotas	100 gab./iepak.	9,19 (7,60)
	Skrūves lokšņu savienošanai 4.8 x 23 mm	krāsotas	100 gab./iepak.	11,20 (9,25)
		cinkotas	100 gab./iepak.	9,92 (8,20)
	Ruukki LP Torx skrūves (RR11, RR23, RR2H3, RR29, RR32, RR33, RR750, RR887)	krāsotas	100 gab./iepak. + 1 uzgalis	13,73 (11,35)
	Magnētiskais turētājs Ruukki LP Torx skrūvēm		1 turētājs un 5 uzgaji	14,45 (11,95)
	Skavas valcprofilam L = 25	Tērauda		0,12 (0,10)
		Nerūsējošā tērauda		0,30 (0,25)
		Nerūsējošā tērauda, slīdošas		0,77 (0,64)
	Nerūsējošā tērauda skrūves Classic jumtu stiprināšanai, kokam 4.2 x 25 mm		100 gab./iepak.	11,25 (9,30)
	Skrūvju komplekts jumta latu regulēšanai	140 mm	100 gab./iepak.	86,45 (71,45)
		170 mm	100 gab./iepak.	93,71 (77,45)
	Fiksators jumta latu regulēšanai			4,30 (3,55)

Remontkrāsas

		Cena €/gab. ar PVN (€/gab. bez PVN)	
Attēls	Nosaukums	Tilpums	
	Krāsa remontam	24 ml	6,96 (5,75)
	Krāsa remontam, matēta	24 ml	6,96 (5,75)
	Krāsa remontam	100 ml	13,79 (11,40)



Blīvējumi

Cena €/gab. ar PVN (€/gab. bez PVN)

Attēls	No	Info	Vienība	
	Universālais blīvējums	H = 50 mm	m	2,90 (2,40)
	Blīvējums Adamante	L = 1 125 mm	gab.	2,84 (2,35)
	Blīvējums Monterrey	L = 1 100 mm	gab.	2,84 (2,35)
	Blīvējums Finnera	L = 1 140 mm	gab.	2,84 (2,35)
	Classic skaņas izolācijas lenta	50 m	rullis	44,35 (36,65)
	Blīvējums Classic, vienasējis pašlīmējošs	100 mm x 5 mm x 20 m	rullis	21,24 (17,55)
	Vienpusēja blīvleņa Permo Absorber	rullī ir 30 metri	rullis	38,90 (32,15)
	Hermētiķis Permo Seal	1000 g	gab.	32,61 (26,95)
	Vienpusēja caurspīdīga līmleņa Ruukki A+	rullī ir 25 metri	rullis	29,71 (24,55)
	Butīla lente Ruukki BUTYL BAND PRO	rullī ir 20 metri	rullis	26,86 (22,20)
	Pašlīmējošā apdares lente Ruukki FLEXO	300 mm x 5 m	rullis	39,63 (32,75)
	Divslāņu ventilācijas lente Ruukki Roll Super	300 mm x 5 m	rullis	21,05 (17,40)
	Vienpusēja līmleņa universāla	90mm x 10m	rullis	55,72 (46,05)
	Hermētiķis mitrām virsmām, caurspīdīgs	280 ml	gab.	16,70 (13,80)

Jumta plēves

Cena €/gab. ar PVN (€/gab. bez PVN)

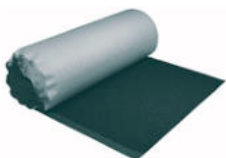
Attēls	Nosaukums	Svars	Info	Daudzums		
	Difūzijas membrāna (ruļļos)	Ruukki175Fix	175 g/m ²	1.5 m x 20 m; 30 m ²		83,37 (68,90)
		Ruukki175Fix	175 g/m ²	1.5 m x 50 m; 75 m ²		214,59 (177,35)
		Ruukki145Fix	145 g/m ²	1.5 m x 20 m; 30 m ²		66,31 (54,80)
		Ruukki145Fix	145 g/m ²	1.5 m x 50 m; 75 m ²		138,67 (114,60)
	Antikondensāta plēve Ruukki® 50 Plus			1.5 m x 20 m; 30 m ²		60,20 (49,75)
	Antikondensāta plēve Ruukki® 50 Plus			1.5 m x 40 m; 60 m ²		107,39 (88,75)
	Antikondensāta plēve Ruukki® 30			1.5 m x 40 m; 60 m ²		59,05 (48,80)
	Jumta membrāna Permo sec SK			1.5 m x 25 m; 37.5 m ²	1 m ²	10,60 (8,76)
	Jumta membrāna ventilācijas šķirkārtas nodrošināšanai starp valcējamiem jumtiem un apakšklāju				Rullis	397,42 (328,45)

Lūkas



Cena €/gab. ar PVN (€/gab. bez PVN)

Attēls	Nosaukums	Info	
	Lūka, tērauda	Lūka Classic (integrētā), 800 x 600 mm	298,26 (246,50)
		Lūka Classic, 800 x 600 mm	298,26 (246,50)
		Lūka (universālā), 800 x 600 mm	298,26 (246,50)

Attēlam ir ilustratīvs raksturs.







Ventilācijas izvadi un pieslēgumi

Cena €/gab. ar PVN (€/gab. bez PVN)

Attēls	Nosaukums	Diametrs		
	Izolēts ventilācijas izvads ar jumtiņu FLOW	110 mm ø	h=500 mm	89,72 (74,15)
	Izolēts ventilācijas izvads FLOW 125P/IS/700	125 mm ø	h=700 mm	154,15 (127,40)
	Izolēts ventilācijas izvads FLOW 160P/IS/700 * Pēc speciāla pasūtījuma	160 mm ø	h=700 mm	269,28 (222,55)





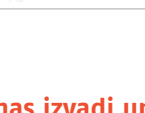

Pieslēgumi ventilācijas izvadiem

Cena €/gab. ar PVN (€/gab. bez PVN)

Attēls	Nosaukums	Info	
	Pieslēgums ventilācijas izvadam, Classic		58,02 (47,95)
	Pieslēgums ventilācijas izvadam, Adamante		60,02 (49,60)
	Pieslēgums ventilācijas izvadam, Monterrey		42,65 (35,25)
	Pieslēgums ventilācijas izvadam, Finnera		49,12 (40,60)
	Pieslēgums ventilācijas izvadam, universāls		79,74 (65,90)
	Pieslēgums ventilācijas izvadam, Hygge		49,12 (40,60)
	Vilpe 2K hidroizolācijas hermētiķis		25,59 (21,15)

Antenas izvadi un Solar pieslēgumi

Cena €/gab. ar PVN (€/gab. bez PVN)

Attēls	Nosaukums	Info	
	Antenas izvads	∅ 12–102 mm	58,50 (48,35)
	Antenas izvads	∅ 6–146 mm	47,01 (38,85)
		∅ 121–254 mm	87,79 (72,55)
	Solar pieslēguma elements Classic		86,76 (71,70)
	Solar pieslēguma elements Monterrey		86,76 (71,70)
	Solar pieslēguma elements profilētām loksņēm		142,05 (117,40)
	Solar blīvslēgs		18,76 (15,50)

Ruukki Ø 125 mm ūdensnoteku sistēmas krāsas

Dakstiņšarkana (RR750)	Sarkana (RR29)	Šokolādes brūna (RR887)	Tumši brūna (RR32)	Balta (RR20)	Sudrabota (RR40)
Tumši pelēka (RR23)	Antracīta (RR2H3)	Melna (RR33)			

Ruukki Ø 150 mm ūdensnoteku sistēmas krāsas

Tumši pelēka (RR23)	Tumši brūna (RR32)
---------------------	--------------------

Ruukki Ø 125 mm matētas ūdensnoteku sistēmas krāsas

Melna (RR33)

MONTĀŽAS INSTRUKCIJA

YouTube
www.ruukki.lv/r



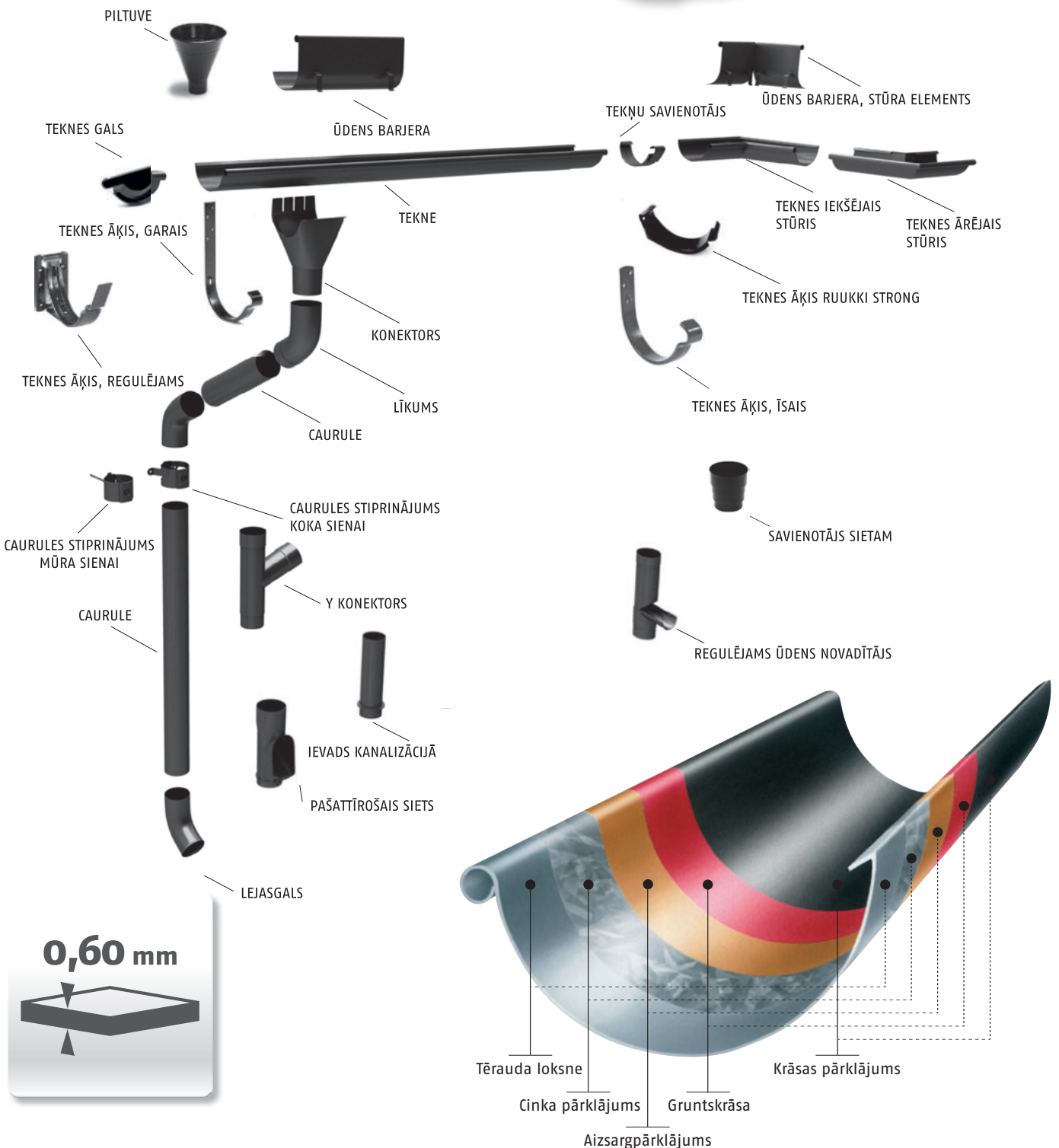







Citas krāsas Ø 150 mm ūdensnotekām pieejamas pēc speciāla pasūtījuma



Lietus ūdensnoteku sistēmas

Teknes un to piederumi









Cena €/gab. ar PVN (€/gab. bez PVN)

Attēls	Nosaukums	Teknes platums	Info	Standarta pārklājums	Matēts pārklājums (RR33)
	Tekne	125 mm	3.0 m	26,87 (22,15)	26,87 (22,15)
		125 mm	4.0 m	32,91 (27,20)	32,91 (27,20)
		150 mm	3.0 m	28,68 (23,70)	
		150 mm	4.0 m	35,03 (28,95)	
	Teknes stūris, ārējais, 90°	125 mm	90°	19,12 (15,80)	19,12 (15,80)
		150 mm	90°	20,39 (16,85)	
	Teknes stūris, iekšējais, 90°	125 mm	90°	19,12 (15,80)	19,12 (15,80)
		150 mm	90°	20,39 (16,85)	
	Teknes stūris, ārējais, 135°	125 mm	135°	48,10 (39,75)	
		150 mm	135°	49,31 (40,75)	
	Teknes stūris, iekšējais, 135°	125 mm	135°	48,10 (39,75)	
		150 mm	135°	49,31 (40,75)	
	Teknes gals Combi	125 mm	1 gab.	5,32 (4,40)	5,32 (4,40)
		150 mm	1 gab.	5,81 (4,80)	
	Tekņu savienotājs	125 mm		5,08 (4,20)	5,08 (4,20)
		150 mm		5,45 (4,50)	
	Teknes āķis Ruukki Strong	125 mm		5,08 (4,20)	
	Teknes āķis, regulējamais	125 mm		5,32 (4,40)	5,32 (4,40)
		150 mm		8,89 (7,35)	
	Teknes āķis, īsais 55	125 mm	50 mm	4,17 (3,45)	4,17 (3,45)
		150 mm*	50 mm	4,96 (4,10)	
	Teknes āķis, garais	125 mm	205 mm	6,96 (5,75)	6,96 (5,75)
		150 mm	205 mm	8,77 (7,25)	8,77 (7,25)

* pieejams tikai pēc speciāla pasūtījuma







Notekcaurules piederumi

Cena €/gab. ar PVN (€/gab. bez PVN)

Attēls	Nosaukums	Izmērs	Info	Standarta pārklājums	Matēts pārklājums (RR33)
	Caurule	Ø 90 mm	garums 1.0 m	14,76 (12,20)	14,76 (12,20)
		Ø 90 mm	garums 2.5 m	29,52 (24,40)	29,52 (24,40)
		Ø 90 mm	garums 4.0 m	43,50 (35,95)	43,50 (35,95)
		Ø 100 mm	garums 21.0 m	15,49 (12,80)	
		Ø 100 mm	garums 2.5 m	33,52 (27,70)	
		Ø 100 mm	garums 4.0 m	48,22 (39,85)	
	Konektors	Ø 125/90 mm		11,31 (9,35)	11,31 (9,35)
		Ø 125/100 mm		11,31 (9,35)	
		Ø 150/90 mm		13,79 (11,40)	
		Ø 150/100 mm		14,58 (12,05)	
	Piltuve	Ø 90 mm		47,49 (39,25)	
		Ø 100 mm		51,97 (42,95)	
	Līkums	Ø 90 mm	70°	8,65 (7,15)	8,65 (7,15)
		Ø 100 mm	70°	9,26 (7,65)	
	Y konektors	Ø 90 mm		47,73 (39,45)	47,73 (39,45)
		Ø 100 mm		60,44 (49,95)	
	Caurules stiprinājums ar ķīli koka sienai	Ø 90 mm		4,17 (3,45)	4,17 (3,45)
		Ø 100 mm		4,78 (3,95)	
	Caurules stiprinājums ar ķīli mūra sienai	Ø 90 mm		4,17 (3,45)	4,17 (3,45)
		Ø 100 mm		4,78 (3,95)	
	Skrūve mūra sienai		125 mm	3,26 (2,70)	
			200 mm	4,29 (3,55)	
			300 mm	4,65 (3,85)	
	Lejasgals	Ø 90 mm	70°	11,92 (9,85)	11,92 (9,85)
		Ø 100 mm	70°	15,37 (12,70)	

Notekcaurules piederumi

Cena €/gab. ar PVN (€/gab. bez PVN)

Attēls	Nosaukums	Izmērs	Info	Standarta pārklājums	Matēts pārklājums (RR33)
	Ievads kanalizācijā	ø 90 mm		34,30 (28,35)	34,30 (28,35)
		ø 100 mm		44,17 (36,50)	
	Regulējams ūdens novadītājs	ø 90 mm		53,12 (43,90)	
		ø 100 mm		68,06 (56,25)	
	Cauruļu savienotājs	ø 90 mm		6,83 (5,65)	6,83 (5,65)
		ø 100 mm		10,83 (8,95)	
	Pašattīrošais lapu siets (plastmasas)		augstums 325 mm	18,09 (14,95)	
	Savienotājs sietam (plastmasas)		80–150 mm	11,07 (9,15)	
	Ūdens barjera teknei		garums 350 mm augstums 95 mm	25,59 (21,15)	
	Ūdens barjera teknei, stūra elements		175x175 mm augstums 83 mm	28,44 (23,50)	

Ruukki standarta ūdensnoteku sistēmas krāsas

Dakstiņšarkana (RR750)	Sarkana (RR29)	Šokolādes brūna (RR887)
Tumši brūna (RR32)	Balta (RR20)	Sudrabota (RR40)
Tumši pelēka (RR23)	Antracīta (RR2H3)	Melna (RR33)

Ruukki ø 150 mm ūdensnoteku sistēmas krāsas

Tumši pelēka (RR23)	Tumši brūna (RR32)
---------------------	--------------------

Citas krāsas ø 150 mm ūdensnotekām pieejamas pēc speciāla pasūtījuma

Ruukki matētas ūdensnoteku sistēmas krāsas

Melna (RR33)

JAUNUMS!

Dziļo tekņu sistēmas Ruukki Siba Tech

Divu formu kombinācija palielina Ruukki Siba Tech sistēmas caurplūdi vēl efektīvāku salīdzinājumā ar citām tirgū pieejamām sistēmām.

Novatoriskā teknes forma un stūra konstrukcija, kas iegūta apvienojot divas formas, nodrošina efektīvu tekņu sistēmas caurlaidību, palielina elementu izturību un uzlabo estētisko ēkas kopskatu.

Tā gādā par efektīvu lietus ūdens aizvadīšanu no jumta un plašā tekņu āķu izvēle ļauj uzstādīt sistēmu jebkura veida jumtam. Lielisks risinājums gan dzīvojamām, gan sabiedriskajām ēkām.



Pusapaļā puse

- 1 Tekne
- 2 Ārējais pusapaļais stūris
- 3 Iekšējais pusapaļais stūris
- 4 Tekņu savienotājs
- 5 Teknes gals
- 6 Āķis
- 7 Apaļā notekcaurule
- 8 Apaļās caurules konektors
- 9 Līkums
- 10 Lejasgals
- 11 Notekcaurules stiprinājums koka sienai
- 12 Notekcaurules stiprinājums betona sienai

JAUNUMS!



Kantainā puse

- 1 Tekne
- 2 Kantainais ārējais stūris
- 3 Kantainais iekšējais stūris
- 4 Tekņu savienotājs
- 5 Teknes gals
- 6 Āķis
- 7 Kantainā notekcaurule
- 8 Kantainās notekcaurules konektors
- 9 Līkums / lejasgals
- 10 Kantainās notekcaurules stiprinājums koka sienai
- 11 Kantainās notekcaurules stiprinājums betona sienai











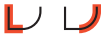







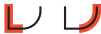







Siba Tech ūdensnoteku sistēmas krāsas

























Šokolādes brūna
(RR887)

Tumši pelēka
(RR23)

Antracīta
(RR2H3)











Melna
(RR33)

Attēls	Nosaukums	Izmērs	Garums	Skaitis iepakojumā	Cena ar PVN
	Tekne 	140 mm	3,0 m	3	32,43 (26,80)
		140 mm	4,0 m	3	39,87 (32,95)
	Kantainais iekšējais / pusapaļais ārējais stūris 	140 mm		15	18,09 (14,95)
	Kantainais ārējais / pusapaļais iekšējais stūris 	140 mm		15	18,09 (14,95)
	Tekņu savienotājs 	140 mm		20	8,71 (7,20)
	Teknes gals, kreisais kantainais / labais pusapaļais 	140 mm		50	4,30 (3,55)
	Teknes gals, labais kantainais / kreisais pusapaļais 	140 mm		50	4,30 (3,55)
	DDC P tipa āķis, kantainais 	140 mm		25	9,92 (8,20)
	DDC H tipa āķis, kantainais 	140 mm		30	5,20 (4,30)
	Garais āķis, kantainais 	140 mm		25	10,71 (8,85)
	DDC P tipa āķis, pusapaļais 	140 mm		25	9,92 (8,20)
	DDC H tipa āķis, pusapaļais 	140 mm		30	5,20 (4,30)
	Garais āķis, pusapaļais 	140 mm		25	10,71 (8,85)
	Kantainā notekcaurule 	80 x 80 mm	1,0 m	2	13,55 (11,20)
		80 x 80 mm	3,0 m	2	36,12 (29,85)
	Kantainās notekcaurules konektors 	140 / 80 x 80		20	11,37 (9,40)



Attēls	Nosaukums	Izmērs	Garums	Skaitis iepakojumā	Cena ar PVN
	Līkums / lejasgals, kantainais 	80 x 80 mm		25	11,92 (9,85)
	Kantainās notekcaurules stiprinājums betona sienai 	80 x 80 mm		20	4,17 (3,45)
	Kantainās notekcaurules stiprinājums koka sienai 	80 x 80 mm		20	4,17 (3,45)
	Apaļā notekcaurule 	90 mm	3000 mm	2	36,06 (29,80)
		90 mm	1000 mm	2	14,76 (12,20)
	Apaļās notekcaurules konektors 	140 /90		20	11,37 (9,40)
	Līkums 	90 mm		16	8,65 (7,15)
	Lejasgals 	90 mm		16	11,92 (9,85)
	Notekcaurules stiprinājums betona sienai 	90 mm		15	4,17 (3,45)
	Notekcaurules stiprinājums koka sienai 	90 mm		15	4,17 (3,45)
	Stiprinājuma skrūve betona sienai 	125 mm			3,26 (2,70)
		175 mm			4,12 (3,40)
		200 mm			4,29 (3,55)
		250 mm			4,48 (3,70)
		300 mm			4,65 (3,85)
	Ievads kanalizācijā kantainajai caurulei* 			1	34,30 (28,35)
	Ievads kanalizācijā apaļajai caurulei* 			1	34,30 (28,35)

* Elements izgatavots no PVC

Slēgtā lietus ūdensnoteku sistēma

		Cena €/gab. ar PVN (€/gab. bez PVN)		
Attēls	Nosaukums	Teknes platums	Info	
	Tekne	150 mm	2.0 m	24,68 (20,40)
		150 mm	4.0 m	35,03 (28,95)
	Teknes konektors	150/100 mm		17,18 (14,20)
	Teknes āķis	150 mm		24,08 (19,90)
	Tekņu savienotājs	150 mm		10,65 (8,80)
	Teknes stūris, ārējais, 90°	150 mm		20,39 (16,85)
	Teknes stūris, iekšējais, 90°	150 mm		20,39 (16,85)
	Teknes gals Combi	150 mm		6,29 (5,20)
	Priekšējā maskējošā detaļa L=2400 mm	Ruukki® 50 Plus matt		35,88 (29,65)
		Ruukki® 40		32,31 (26,70)
	Iekšējā stūra maskējošā detaļa 210 x 210 mm	Ruukki® 50 Plus matt		9,08 (7,50)
		Ruukki® 40		8,23 (6,80)
	Gala / ārējā stūra maskējošā detaļa 210 x 210 mm	Ruukki® 50 Plus matt		9,08 (7,50)
		Ruukki® 40		8,23 (6,80)

Cena €/gab. ar PVN (€/gab. bez PVN)

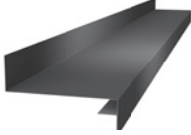
Attēls	Nosaukums	Info	
	Maskējošā detaļa L=2400 mm		29,95 (24,75)
	Gala maskējošā detaļa		16,03 (13,25)
	Augšējā karnīze L=2400 mm	Ruukki® 50 Plus matt	19,48 (16,10)
		Ruukki® 40	18,51 (15,30)
	Apakšējā karnīze L=2400 mm	Ruukki® 50 Plus matt	36,00 (29,75)
		Ruukki® 40	31,22 (25,80)

Slēgtās lietus ūdensnoteku sistēmas krāsas

RR22*









RR23*

RR2H3*

RR33*

*Pēc pasūtījuma

Cena €/gab. ar PVN (€/gab. bez PVN)

Attēls	Nosaukums	Izmērs	Info	
	PVC caurule	110 mm	3.0 m	27,28 (22,55)
	PVC caurules stiprinājums	110 mm	90 mm garums	5,45 (4,50)
			150 mm garums	8,05 (6,65)
	PVC 87° līkums	110 mm		5,38 (4,45)
	PVC 30° līkums ¹	110 mm		4,72 (3,90)
	Caurules izolācija		1,0 m	10,53 (8,70)
	Caurules blīvējums	110 mm		8,59 (7,10)
	Caurules savilce	110 mm		5,93 (4,90)
	Kolektora kaste	110 mm	200 x 200 x 200 mm	70,54 (58,30)

¹ Montāžas piemērs, ja tiek izmantoti 2 līkumi. Komplektā ir 1 līkums

Dzegas apšuvums Ruukki Soffit

Tehniskie dati un cenas

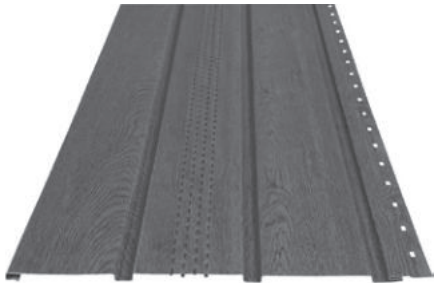

* Iespējams pasūtīt loksnes nepieciešamajā garumā

Profila augstums	7,5 mm
Cinka daudzums	275 g/m ²
Minimālais garums	300 mm
Maksimālais garums	3 600 mm
Materiāla biezums	0,5 mm
Lietderīgā platība	1,13 m ² /gab.
Lokšņu skaits iepakojumā	44 gab.

Nosaukums	Ruukki® 30 Plus Matt	Ruukki® 30
Soffit	33,15 (27,40)	32,31 (26,70)

Cena €/gab. ar PVN (€/gab. bez PVN)

Attēls	Nosaukums	Kvalitātes klase	
	Sākuma elements „J” 2000 mm	Ruukki 30	13,07 (10,80)
		Ruukki 30 Plus Matt	13,55 (11,20)
	Iekšējais stūris Ārējais stūris 2000 mm	Ruukki 30	10,65 (8,80)
		Ruukki 30 Plus Matt	11,25 (9,30)
	Nerūsējošā tērauda skrūves Classic jumtu stiprināšanai 4.2 x 25 mm 100 gab./iepak.		11,25 (9,30)

Krāsas









Balta (RAL9010)	Šokolādes brūna (RR887)	Tumši pelēka (RR23)	Antracīta (RR2H3)	Melna (RR33)
---------------------------	-----------------------------------	-------------------------------	-----------------------------	------------------------

* Balts ir tikai Ruukki 30

Jumta drošības elementi, STANDARTA SORTIMENTS





Kāpnes

Cena €/gab. ar PVN (€/gab. bez PVN)

Attēls	Nosaukums	Info	
	Kāpnes SafeGrip (krāsotas), platums 400 mm	1.2 m	55,60 (45,95)
		2.7 m	106,90 (88,35)
		3.3 m	130,62 (107,95)
	Kāpņu metāla balstiņi	pāris	14,46 (11,95)
	Kāpņu montāžas komplekts ēkas sānos	1000 mm	167,77 (138,65)
	Loka stiprinājumi pie kāpnēm		47,92 (39,60)
	Papildstiprinājumi sienas kāpnēm	1000 mm	50,88 (42,05)
	Loka stiprinājumi pie laipas		19,12 (15,80)
	Loka stiprinājumi pie parapeta	pāris	40,47 (33,45)
	Jumta kāpņu montāžas komplekts	5m dakstiņveida profiliem	60,32 (49,85)
	Jumta kāpņu montāžas komplekts	5m Uniseam Classic, Valc-profilam	106,66 (88,15)

Jumta laipas

Cena €/gab. ar PVN (€/gab. bez PVN)

Attēls	Nosaukums	Info	
	Jumta laipa	600 mm	34,97 (28,90)
		1400 mm	93,05 (76,90)
		3000 mm	138,18 (114,20)
	Stiprinājums UniSeam, pāris ¹	Adamante, Monterrey	42,59 (35,20)
		Finnera	42,59 (35,20)
		T20	42,59 (35,20)
		Hyygge	42,59 (35,20)
	Stiprinājums UniSeam, pāris ^{1,3}	Classic, Valcprofilam	49,85 (41,20)
	Jumta laipas slīpuma regulēšanas plāksne, pāris³	Slīpuma regulēšana 5-45 grādi	21,00 (17,35)
	Drošības troses stiprinājums pie laipas¹		70,97 (58,65)





¹ Komplektā ir visi nepieciešamie montāžas piederumi.

² Cenā ietilpst arī jumta laipas turētāja plāksnes ar visiem stiprinājumiem.

³ Jumta laipas uzstādīšanai 5°-45° jumtiem papildus stiprinājumam ir jāizmanto plāksnes komplekts.

Sniega barjeras

Cena €/gab. ar PVN (€/gab. bez PVN)

Attēls	Nosaukums	Info	
	Sniega aiztures barjeras caurule, ovāla L= 3 m	Zn	20,99 (17,35)
		krāsota	29,10 (24,05)
	Sniega aiztures barjeras stiprinājumi	profilētiem/dakstiņveida; Zn	15,00 (12,40)
		profilētiem/dakstiņveida; krāsoti	18,82 (15,55)
		Classic; Zn	17,91 (14,80)
		Classic; krāsoti	24,87 (20,55)
		Valcprofilam; Zn	17,91 (14,80)
		Valcprofilam; krāsoti	24,87 (20,55)
	Distancers sniega barjerai / jumta laipai (skrūve+gumijas paplāksnis)	Adamante, Finnera	3,38 (2,80)
	Sniega aiztures barjeras caurule, apaļa L= 3 m	krāsota	27,71 (22,90)









Jumta drošības elementu krāsas

Dakstiņšarkana (RR750)	Sarkana (RR29)	Šokolādes brūna (RR887)	Tumši brūna (RR32)	Skuju zaļa (RR11)	Gaiši pelēka (RR21)
Tumši pelēka (RR23)	Melna (RR33)				

Jumta drošības elementi, UZ PASŪTĪJUMU

Kāpnes





Cena €/gab. ar PVN (€/gab. bez PVN)

Attēls	Nosaukums	Info	
	Kāpnes 700 mm	1.8 m	117,92 (97,45)
		3.0 m	142,24 (117,55)
	Kāpņu plastmasas balstiņi	pāris	10,04 (8,30)
	Kāpņu montāžas komplekts ēkas sānos	1000 mm	156,70 (129,50)
	Kāpņu montāžas komplekts	profilētiem/dakstiņveida	59,53 (49,20)
		Classic, Valcprofilam	93,53 (77,30)
	Papildstiprinājums sienas kāpnēm	pāris	47,71 (39,43)
	Kāpņu stiprinājums pie jumta laipas		19,30 (15,95)
	Vertikālā drošības sliede pie kāpnēm		104,97 (86,75)
	Vertikālās drošības sliedes priekšgals		265,96 (219,80)
	Vertikālās drošības sliedes savienojums		21,24 (17,55)

Cenu piedāvājums tiek veidots pēc pieprasījuma.

Stiprinājumi vertikālai slidei





Cena €/gab. ar PVN (€/gab. bez PVN)

Attēls	Nosaukums	
	Pakāpiena stiprinājums	27,89 (23,05)
	Pielāgojamais karabīnes fiksators (slides augšgalam)	69,76 (57,65)
	Fiksētais karabīnes fiksators (slides augšgalam)	32,97 (27,25)
	Slīdošā drošības karabīne	480,12 (396,80)

Cenu piedāvājums tiek veidots pēc pieprasījuma.

Stiprinājumi horizontālai slidei





Cena €/gab. ar PVN (€/gab. bez PVN)

Attēls	Nosaukums	
	Horizontālā drošības sliede pie laipas	139,51 (115,30)
	Karabīne	326,45 (269,80)
	Pielāgojamais karabīnes fiksators	42,53 (36,15)
	Fiksētais karabīnes fiksators	20,45 (16,90)

Cenu piedāvājums tiek veidots pēc pieprasījuma.

Solāro paneļu stiprinājumi













Cena €/gab. ar PVN (€/gab. bez PVN)

Attēls	Nosaukums	Mērvienība	
Ruukki Classic un Valcprofila jumtiem			
	Saules paneļu stiprinājums Uniseam (680P) RR33/Melns	gab.	7,50 (6,20)
	Sniega barjeras stiprinājuma klemme UniSeam + skrūve 8x35 (671P) RR33	gab.	3,57 (2,95)
Tērauda dakstiņveida un trapecveida jumtiem			
	Saules paneļu stiprinājums 425 (681) RR33/Melns	gab.	11,74 (9,70)
	Blīvējums tērauda jumtam, pāris 2+1 (582P)	gab.	0,61 (0,50)
	Gumijas blīves/ pāris (589)	gab.	0,67 (0,55)
	Jumta drošības skrūve 7,0x 50mm (665P)	gab.	0,11 (0,09)
Dakstiņu jumtiem			
	Saules paneļu stiprinājums dakstiņu jumtam (682P) RR33	gab.	13,86 (11,45)
	Saules paneļu papildstiprinājums dakstiņu jumtam (568P) RR33	gab.	12,04 (9,95)
Plakanā tipa jumtiem (bitumena un PVC)			
	Saules paneļu stiprinājums 425 (681) RR33/Melns	gab.	11,74 (9,70)
	Saules paneļu stiprinājums plakaniem jumtiem (683P) RR33	gab.	7,38 (6,10)
	Montāžas plāksne ūdensizturīgajai jumta membrānai (576P)	gab.	22,47 (21,40)
	Montāžas plāksnes skrūve 10x30mm A2 (662P)	gab.	1,39 (1,15)
	Uzgrieznis M10 DIN6923 A2 (663P)	gab.	0,30 (0,25)

Cenu piedāvājums tiek veidots pēc pieprasījuma.

Safeline Drošības trošu sistēmas elementi

Cena €/gab. ar PVN (€/gab. bez PVN)

Attēls	Nosaukums	Kods	Mērvienība	
	952 Safeline troses kronšteins (ar skrūvēm un uzgriežņiem)	34300 34443 x 2 82468 x 2	gab.	48,22 (39,85)
	953 Safeline troses kronšteins kāpnēm (ar skrūvēm un uzgriežņiem)	34300 34301 34443 x 2 82468 x 2	gab.	67,28 (55,60)
	954 Kustīgā elementa stoperis kāpnēm	34303	gab.	48,82 (40,35)
	955 Kustīgā elementa beigu kronšteins	34306	gab.	22,51 (18,60)
	956 Troses beigu kronšteins (skrūve komplektā)	34323	gab.	24,75 (20,45)
	957 Troses nobeiguma uzdeva	34317	gab.	13,67 (11,30)
	958 Kustīgais elements 8mm tērauda trosei	34318	gab.	137,46 (113,60)
	959 Safeline kronšteina fiksējošais balsts, RR33			26,50 (21,90)
	960 Fiksējošā balsta blīve, EPDM			1,45 (1,20)
	964 Safeline montāžas plāksne tērauda jumtiem 302,5mm x 302,5mm			27,77 (22,95)
	967 pagarināšanas termināļi trosei			31,70 (26,20)
	965 8 mm trose dažādi garumi	34252	50 m	630,77 (521,30)
	966 8 mm troses spole	34253	100 m	1199,71 (991,50)



Cena €/m ar PVN (€/m bez PVN)

Attēls	Nosaukums	Kods	Mērvienība	
	984 nerūsējošā tērauda 8 mm trose ar gala spailēm, dažādi garumi		1-10 m	21,24 (17,55)
			11-20 m	19,66 (16,25)
			21-30 m	18,39 (15,20)
			31-40 m	17,30 (14,30)
			41-50 m	16,46 (13,60)
			51-100 m	15,79 (13,05)
			101-250 m	15,31 (12,65)
	251-100 m	14,94 (12,35)		

JAUNUMS!

SafeLine Drošības trošu sistēmas elementi

Cena €/gab. ar PVN (€/gab. bez PVN)

Attēls	Nosaukums	Kods	Mērvienība
	961 SafeLine brīvēstāvošs komplekts vertikālo šuvju jumtiem. (ieskaitot UniSeam platformu, SafeLine kronšteina fiksējošo balstu, blīvi, 30mm montāžas skrūvi un M10 uzgriežņi, troses kronšteinu ar skrūvēm un uzgriežņiem)		315,27 (260,55)
	962 SafeLine brīvēstāvošs komplekts plakanajiem jumtiem. (ieskaitot plakano kjumtu montāžas plāksni, SafeLine kronšteina fiksējošo balstu, blīvi, 30mm montāžas skrūvi un M10 uzgriežņi, troses kronšteinu ar skrūvēm un uzgriežņiem)		105,55 (87,23)
	963 SafeLine brīvēstāvošs komplekts profilētajiem tērauda jumtiem (ieskaitot SafeLine fiksējošo plāksni tērauda jumtiem, SafeLine kronšteina fiksējošo balstu, blīvi, 30mm montāžas skrūvi un M10 uzgriežņi, troses kronšteinu ar skrūvēm un uzgriežņiem)		93,96 (77,65)

Cenu piedāvājums tiek veidots pēc pieprasījuma.

Cilvēku drošības barjeras

Cena €/gab. ar PVN (€/gab. bez PVN)

Attēls	Nosaukums	Profīls
	Cilvēku drošības un sniega barjera (4 cauruļļu)	profilētiem/dakstiņveida
	L = 6.0 m	Valcprofīls
	H = 0.6 m	Classic
	Iespējams pasūtīt cilvēku drošības un sniega barjeru ar augstumu 1.2 m	
		482,19 (398,50)
		535,61 (442,65)
		535,61 (442,65)

Profilētās loksnes sienām

Cena €/m² ar PVN (€/m² bez PVN)

Attēls	Nosaukums	Biezums	Kvalitātes klase	
	T20-79-1100 T20-24-1100	0.50 mm	Ruukki® 50 Plus Matt	22,57 (18,65)
		0.50 mm	Ruukki® 30	15,67 (12,95)
		0.50 mm	Zn	14,88 (12,30)
	T45-30-905 T45-60-905	0.50 mm	Ruukki® 50 Plus Matt	56,38 (21,80)
		0.50 mm	Ruukki® 30	19,84 (16,40)
		0.50 mm	Zn	18,27 (15,10)
		0.60 mm	Zn	20,75 (17,15)
		0.70 mm	Zn	23,41 (19,35)

0,5 un 0,6 mm biežam materiālam cinka daudzums ne mazāk kā 350 g/m²
0,7 mm biežam materiālam cinka daudzums ne mazāk kā 275 g/m²

Ruukki® 50 Plus Matt Kvalitātes klases krāsas

Dakstiņu sarkana (RR750)	Sarkana (RR29)	Šokolādes brūna (RR887)	Tumši brūna (RR32)	Skuju zāja (RR11)	Gaiši pelēka (RR21)
Pelēka (RR22)	Tumši pelēka (RR23)	Antracīta (RR2H3)	Melna (RR33)		

Ruukki® 30 Kvalitātes klases krāsas

Dakstiņu sarkana (RR750)	Sarkana (RR29)	Gaiši brūna (RR30)	Tumši brūna (RR32)	Zāja (RR37)	Skuju zāja (RR11)
Balta (RR20)	Gaiši pelēka (RR21)	Pelēka (RR22)	Tumši pelēka (RR23)	Melna (RR33)	Sudraba (RR946)

Cena €/gab. ar PVN (€/m² bez PVN)

Attēls	Nosaukums	Info	
	Caurspīdīga loksne T20-24W-1100	5m / 5,5 m ²	171,03 (141,35)
	Caurspīdīga loksne T45-30W-905	5m / 4,53 m ²	203,13 (167,88)

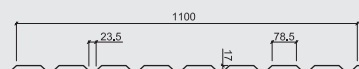
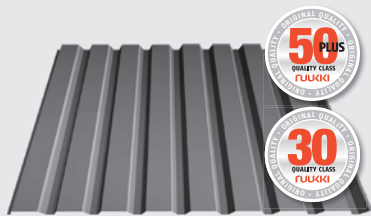

T20-79-1100

Sedzošais platums	1 100 mm
Profila augstums	17 mm
Minimālais garums	500 mm
Maksimālais garums	8 000 mm
Vilņa platums	79 mm

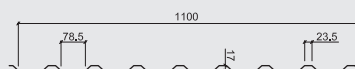
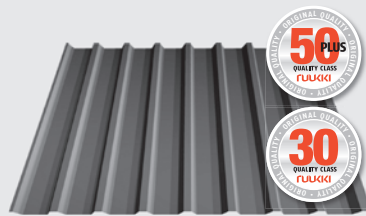

T20-24-1100

Sedzošais platums	1 100 mm
Profila augstums	17 mm
Minimālais garums	500 mm
Maksimālais garums	8 000 mm
Vilņa platums	24 mm

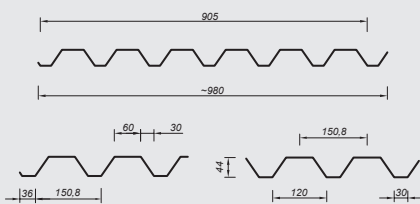

T45-60-905

Sedzošais platums	905 mm
Profila augstums	41 mm
Minimālais garums	500 mm
Maksimālais garums	9 000 mm
Vilņa platums	62 mm

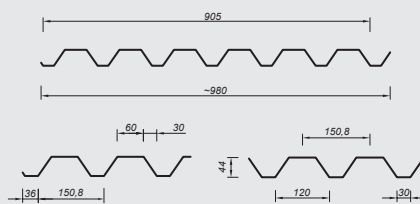
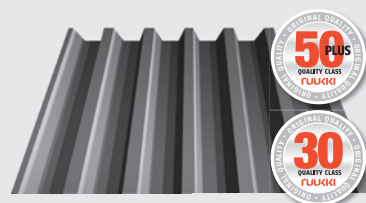

T45-30-905

Sedzošais platums	905 mm
Profila augstums	41 mm
Minimālais garums	500 mm
Maksimālais garums	9 000 mm
Vilņa platums	37 mm

Tērauda loksnes

Cena €/m² ar PVN (€/m² bez PVN)

Attēls	Kvalitātes klase	Biezums	Nosaukums	
	Ruukki® 50 Plus Matt	0,60 mm		21,30 (17,60)
	Ruukki® 50 Plus Matt	0,50 mm		19,61 (16,20)
	Ruukki® 50 Plus	0,60 mm		21,30 (17,60)
	Ruukki® 50 Plus	0,50mm		19,61 (16,20)
	Ruukki® 40	0,50 mm		16,34 (13,50)
	Ruukki® 30 Plus Matt	0,50 mm		14,46 (11,95)
	Ruukki® 30	0,50 mm		13,19 (10,90)
	Ruukki® 30	0,45 mm	RR23, RR29, RR32	11,80 (9,75)
	HDG, Zn >350 g/m ²	0,60 mm		14,89 (12,30)
	HDG, Zn >350 g/m ²	0,50 mm		11,98 (9,90)
	Hiarc®	0,60 mm		22,63 (18,70)
	Ruukki® 50 Plus Matt	0,60 mm	TSP* RR23	23,60 (19,50)

* TSP – tērauda loksne profesionāļiem, valcēšanai,

Ruukki® 50 Plus Matt Tērauda loksnes (0.60 mm) krāsas

Tumši pelēka (RR23)	Tumši brūna (RR32)	Melna (RR33)
------------------------	-----------------------	-----------------

Ruukki® 50 Plus Matt Tērauda loksnes krāsas

Dakstiņu sarkana (RR750)	Sarkana (RR29)	Šokolādes brūna (RR887)	Tumši brūna (RR32)	Skuju zaļa (RR11)	Gaiši pelēka (RR21)
Pelēka (RR22)	Tumši pelēka (RR23)	Antracīta (RR2H3)	Melna (RR33)		

Ruukki® 40 Tērauda loksnes krāsas

Sarkana (RR29)	Tumši brūna (RR32)	Tumši pelēka (RR23)	Antracīta (RR2H3)	Melna (RR33)
-------------------	-----------------------	------------------------	----------------------	-----------------

Ruukki® 30 Plus Matt Tērauda loksnes krāsas

Sarkana (RR29)	Tumši brūna (RR32)	Tumši pelēka (RR23)	Antracīta (RR2H3)	Melna (RR33)
-------------------	-----------------------	------------------------	----------------------	-----------------

Ruukki® 30 Tērauda loksnes krāsas

Dakstiņu sarkana (RR750)	Sarkana (RR29)	Šokolādes brūna (RR887)	Tumši brūna (RR32)	Skuju zaļa (RR11)	Balta (RR20)
Gaiši pelēka (RR21)	Pelēka (RR22)	Tumši pelēka (RR23)	Melna (RR33)		

Hiarc® Tērauda loksnes krāsas

Tumši pelēka (RR23)	Sudrabota (RR40)	Tumši sudrabota (RR41)
------------------------	---------------------	---------------------------

Hiarc® Tērauda loksnes krāsas (matētas)

Sudrabota (RR40)	Tumši sudrabota (RR41)
---------------------	---------------------------



Classic profilu veidu salīdzinājums

JAUNUMS!

JAUNUMS!

	Classic				Classic Silence				Classic Design
	Authentic C	C	M	Authentic C	C	M			
	Authentic D	D		Authentic D	D				
Kvalitātes klase	Ruukki® 50 Plus	Ruukki® 30 Plus	Ruukki® 50 Plus	Ruukki® 50 Plus	Ruukki® 50 Plus	Ruukki® 30 Plus	Ruukki® 50 Plus	Ruukki® 50 Plus	
Noturība pret UV stariem	████████	████████	████████	████████	████████	████████	████████	████████	
Noturība pret skrāpējumiem	████████	████████	████████	████████	████████	████████	████████	████████	
Pārklājums	matēts	matēts	matēts	matēts	matēts	matēts	matēts	matēts	
Garantija (tehniskā/estētiskā)	50/25 gadi	30/10 gadi	50/25 gadi	50/25 gadi	50/25 gadi	30/10 gadi	50/25 gadi	50/25 gadi	
Montāža abos virzienos	✓	✓	✓	✓	✓	✓	✓		
Loksnes biezums	✓				✓			✓	
Loksnes mikroprofilējums			✓				✓		
Iestrādāts skaņas izolācijas slānis				✓	✓	✓	✓		

Viem Classic profiliem vienojošās īpašības



Atlocīta priekšējā mala



Noselements šuves galos



Mikroprofilējums skrūvēšanas vietu līnijām



Dakstiņveida profilu salīdzinājums

	Adamante		Monterrey Feb Forma		Monterrey/ Monterrey Eco
Kvalitātes klase	Ruukki® 50 Plus Matt	Ruukki® 30 Plus Matt	Ruukki® 50 Plus Matt	Ruukki® 40	Ruukki® 30
Izskats	strukturēts	strukturēts	strukturēts	viegli strukturēts	gluds
Izturība pret UV-starojumu	●●●●● Ruv4	●●●●○ Ruv3	●●●●● Ruv4	●●●●○ Ruv3	●●●○○○ Ruv2-3
Izturība pret koroziju	●●●●● RC5	●●●●○ RC4	●●●●● RC5	●●●●○ RC5	●●●○○○ RC3
Izturība pret skrāpējumiem	●●●●● ≥4000 g	●●●●○ ≥2500 g	●●●●● ≥4000 g	●●●●○ ≥2500 g	●●●○○○ ≥2000 g
Garantija (tehniskā/estētiskā)	50/25 gadi	30/10 gadi	50/25 gadi	40/15 gadi	30/10 gadi
Loksnes tērauda biezums	0.50 mm	0.50 mm	0.50 mm	0.50 mm	0.45 mm/0.50 mm
Maksimālais loksnes garums	8200 mm	8200 mm	8000 mm	8000 mm	7000 mm
Latojuma solis starp latu centriem/no karnīzes malas līdz otrās lats centram	350 mm/ 300 mm	350 mm/ 300 mm	350 mm/ 280 mm	350 mm/ 280 mm	350 mm/ 300 mm
Profila augstums	55 mm	55 mm	44 mm	44 mm	39 mm
Dubulta nolocītā priekšējā mala			✓	✓	
Priekšējā mala dakstiņu formā	✓		✓	✓	



Modulāro profilu veidu salīdzinājums

	Hyygge	Finnera	Frigge
Kvalitātes klase	Ruukki® 40	Ruukki® 40	Ruukki® 40
	viegli strukturēts	viegli strukturēts	viegli strukturēts
Izskats	pusmatēts	pusmatēts	pusmatēts
Izturība pret UV-starojumu	●●●●○ Ruv3	●●●●○ Ruv3	●●●●○ Ruv3
Izturība pret koroziju	●●●●● RC5	●●●●● RC5	●●●●● RC5
Izturība pret skrāpējumiem	●●●●○ ≥2500 g	●●●●○ ≥2500 g	●●●●○ ≥2500 g
Garantija (tehniskā/estētiskā)	40/15 gadi	40/15 gadi	40/15 gadi
Loksnes tērauda biezums	0.6 mm	0.50 mm	0.50 mm
Maksimālais loksnes garums	343 mm	725 mm	720 mm
Latojuma solis starp latu centriem/no karnīzes malas līdz otrās lats centram	235 mm*/ 250 mm**	330 mm/ 270 mm	350 mm/ 300 mm
Profila augstums	26 mm	52 mm	41 mm
Dubulta nolocītā priekšējā mala		✓	
Priekšējā mala dakstiņu formā		✓	✓

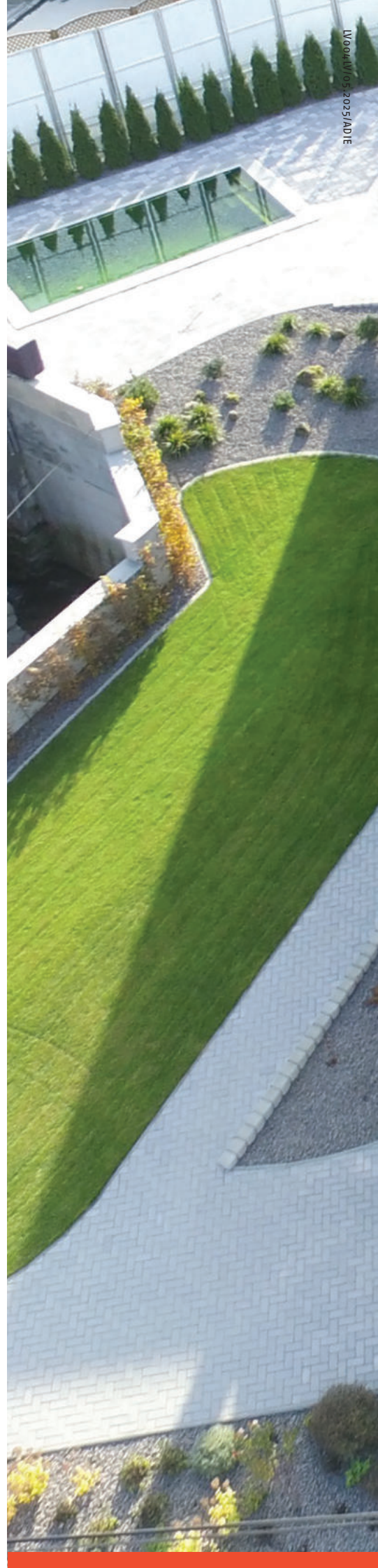

Ruukki informē, ka šajā katalogā norādītās cenas var tikt mainītas un tām ir tikai informatīvs raksturs. Mēs neatbildam par tiešiem vai netiešiem zaudējumiem, kas radušies kļūdas vai neuzmanības rezultātā. Iesakām visus aprēķinus uzticēt mūsu profesionāļiem, lai izvairītos no nepatīkamām situācijām.

www.ruukki.lv.

RUUKKI

Ruukki Products AS Latvijas filiāle, Ābelīšu iela 2, Mārupe, Mārupes novads, LV-2167
tālr.: 80009595, www.ruukki.lv

Autortiesības © 2025 Rautaruukki Corporation. Visas tiesības aizsargātas. Ruukki, Rautaruukki un Ruukki produktu nosaukumi ir Rautaruukki Corporation reģistrētas preču zīmes.